

Non-Isolated Step-Down 3-Terminal DC/DC Converters

BP5275-18 / BP5275-25 / BP5275-33 / BP5275-50

●Description

The BP5275 series of DC/DC converters utilize a synchronous rectification system.

A control circuit, switching element, and coil are built in, along with input/output capacitors, resulting in stable operation with no external components required.

High conversion efficiency, combined with an original heat dissipation structure, enables configuration an ultra-compact switching power supplies.

500mA output is possible with no heat sink required (800mA with heat sink).

In addition, the ICs are pin-compatible with conventional TO-220 LDO regulators, making replacement easy. Low ripple voltage with high precision output ensure stable operation against the fluctuating voltages from main power supplies, making them ideal for use as local power supplies (i.e. for microcontrollers).

●Dimensions (Unit : mm)

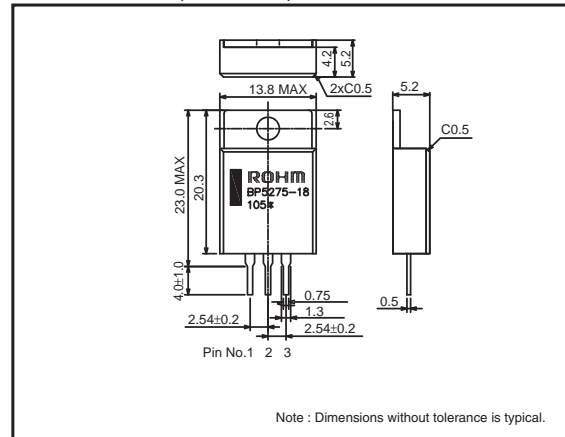

●Applications

Power supplies for copiers, personal computers, facsimiles, AV equipment, measuring instruments, vending machines, security device, registers, industrial equipment, and maintenance tools

●Features

- 1) No external parts required
- 2) High power conversion efficiency.
- 3) Heat sink unnecessary.
- 4) Low output ripple voltage
- 5) High output voltage accuracy
- 6) Pin-compatible with conventional 3-pin LDOs
- 7) Compact package.

BP5275-18 / BP5275-25 / BP5275-33 / BP5275-50 : SIP3

●List of the series

	BP5275-18	BP5275-25	BP5275-33	BP5275-50	Unit
Input voltage	4.5 to 14	4.5 to 14	5.0 to 14	6.0 to 14	V
Output voltage	1.8	2.5	3.3	5.0	V
Maximum output current (no heat sink / include heat sink)	500 / 800	500 / 800	500 / 800	500 / 800	mA
Power conversion efficiency (Vin=12V)	73	78	83	88	%

●Absolute maximum ratings (Ta=25°C)

Parameter	Symbol	Limits				Unit
		BP5275-18	BP5275-25	BP5275-33	BP5275-50	
Input voltage	V _{in}	15	15	15	15	V
Operating temperature range	T _{opr}	-30 to 85	-30 to 85	-30 to 85	-30 to 85	°C
Storage temperature range	T _{stg}	-40 to 105	-40 to 105	-40 to 105	-40 to 105	°C
Allowable maximum surface temperature	T _{cmax}	100	100	100	100	°C
Maximum output current 1	I _{o1max}	500	500	500	500	°C
Maximum output current 2 (with Heat Sink)	I _{o2max}	800	800	800	800	°C

● Block diagram

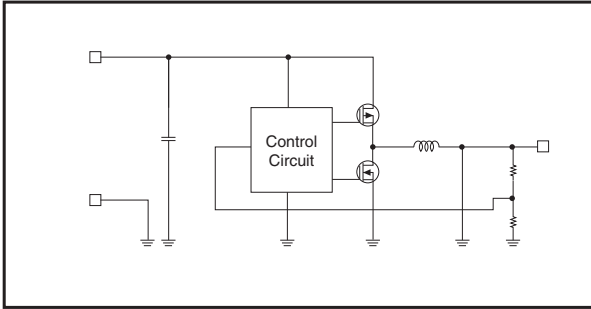

● Measurement circuit

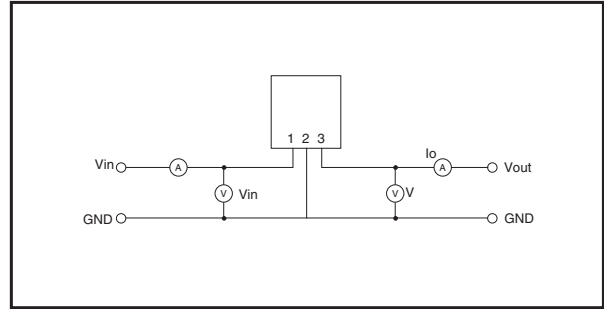

● Electrical characteristics

BP5275-18 (Unless otherwise noted : Ta=25°C, Vin=12V, Io1=500mA)

Parameter	Symbol	Min.	Typ.	Max.	Unit	Conditions
Input voltage	Vin	4	12	14	V	DC
Output voltage	Vo	1.75	1.80	1.85	V	Io1=0mA
Output current 1	Io1	0	-	500	mA	*1
Output current 2	Io2	0	-	800	mA	With heat sink *1
Line regulation	Vr	-	5	50	mV	Vin=4 to 14V
Load regulation	VI	-	10	50	mV	Io=0 to 500mA
Output ripple voltage	Vp	-	5	80	mV _{P-P}	
Minimum start-up time	Ts	4	7	-	msec	Vin=0V → 3V, Ro=3.6Ω
Conversion efficiency	η	65	73	-	%	
Operation frequency	f	-	1.5	-	MHz	

*1 Derating required according to the input voltage and ambient temperature.

BP5275-25 (Unless otherwise noted : Ta=25°C, Vin=12V, Io1=500mA)

Parameter	Symbol	Min.	Typ.	Max.	Unit	Conditions
Input voltage	Vin	4	12	14	V	DC
Output voltage	Vo	2.45	2.50	2.55	V	Io1=0mA
Output current 1	Io1	0	-	500	mA	*1
Output current 2	Io2	0	-	800	mA	With heat sink *1
Line regulation	Vr	-	5	50	mV	Vin=4 to 14V
Load regulation	VI	-	10	50	mV	Io1=0 to 500mA
Output ripple voltage	Vp	-	5	50	mV _{P-P}	
Minimum start-up time	Ts	4	7	-	msec	Vin=3V → 4V, Ro=5Ω
Conversion efficiency	η	73	78	-	%	
Operation frequency	f	-	1.5	-	MHz	

*1 Derating required according to the input voltage and ambient temperature.

● Electrical characteristics

BP5275-33 (Unless otherwise noted : Ta=25°C, Vin=12V, Io1=500mA)

Parameter	Symbol	Min.	Typ.	Max.	Unit	Conditions
Input voltage	Vin	4.5	12	14	V	DC
Output voltage	Vo	3.23	3.30	3.37	V	Io1=0mA
Output current 1	Io1	0	–	500	mA	*1
Output current 2	Io2	0	–	800	mA	With heat sink *1
Line regulation	Vr	–	5	50	mV	Vin=4.5 to 14V
Load regulation	Vl	–	10	50	mV	Io=0 to 500mA
Output ripple voltage	Vp	–	5	50	mV _{P-P}	
Minimum start-up time	Ts	4	7	–	msec	Vin=3V → 4.5V, Ro=6.6Ω
Conversion efficiency	η	78	83	–	%	
Operation frequency	f	–	1.5	–	MHz	

*1 Derating required according to the input voltage and ambient temperature.

BP5275-50 (Unless otherwise noted : Ta=25°C, Vin=12V, Io1=500mA)

Parameter	Symbol	Min.	Typ.	Max.	Unit	Conditions
Input voltage	Vin	6	12	14	V	DC
Output voltage	Vo	4.9	5.0	5.1	V	Io1=0mA
Output current 1	Io1	0	–	500	mA	*1
Output current 2	Io2	0	–	800	mA	With heat sink *1
Line regulation	Vr	–	5	50	mV	Vin=6 to 14V
Load regulation	Vl	–	10	50	mV	Io1=0 to 500mA
Output ripple voltage	Vp	–	5	50	mV _{P-P}	
Minimum start-up time	Ts	4	7	–	msec	Vin=3V → 6V, Ro=10Ω
Conversion efficiency	η	83	88	–	%	
Operation frequency	f	–	1.5	–	MHz	

*1 Derating required according to the input voltage and ambient temperature.

● OPERATION NOTES

- This module will stop outputting because of protection circuit when the input voltage becomes maximum input voltage or less. Please note that the input voltage must not become maximum input voltage in any state of the load.

- After the circuit starts, the output voltage needs to become the fixed voltage within minimum activation time. If the output voltage is below the fixed voltage after the minimum activation time, it doesn't work because of the protection circuit. Please evaluate sufficiently about activation characteristics of input voltage and load characteristics when starting.

- When the output circuit shorts, short-circuit protection of timer-latch type will work and stop outputting. To release the protection, it is necessary to turn on the switch again. This product also has protection element for safety. The protection element is fused if the current, with which the protection element will fuse, will be input by the time the short-circuit protection of timer-latch hangs. Please evaluate sufficiently at using environment about the action when the output circuit shorts.

- There are some case that the heat generates at the module by exceeding allowable maximum surface temperature when the load current which exceeds the maximum output current is electrified. Please make design keeping enough margins not to exceed allowable maximum surface temperature at any time under any application or any test conditions.

- The heat sink at back parts of the product is connected to GND. Please mind the arrangement not to contact with surrounding parts.

●BP5275-18

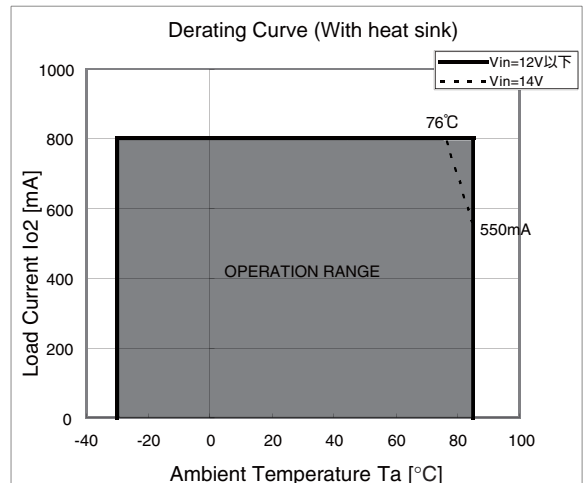
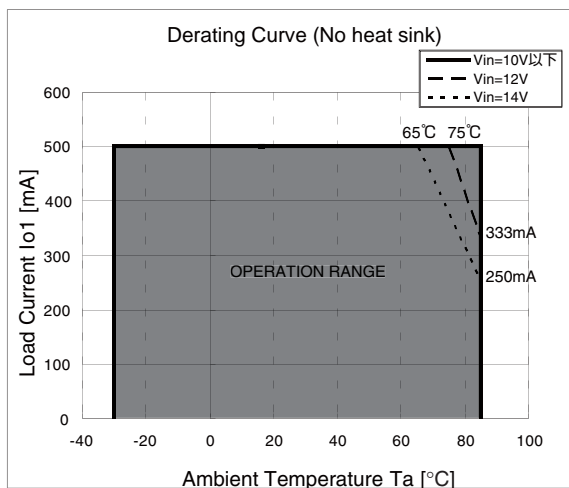
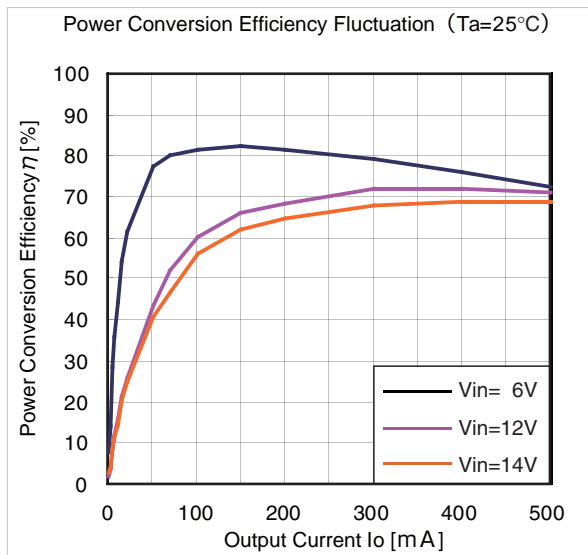
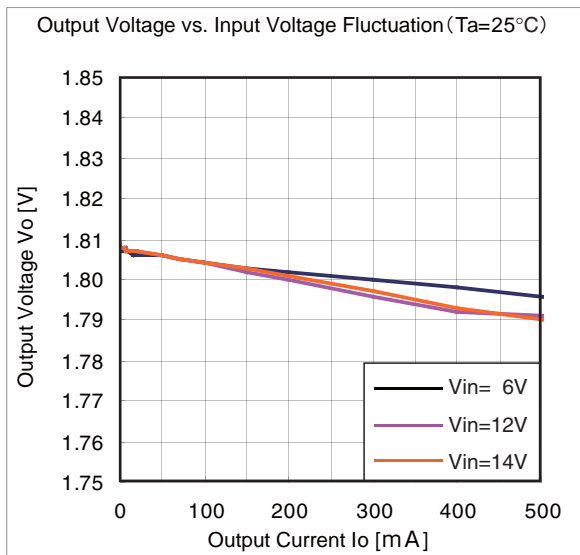
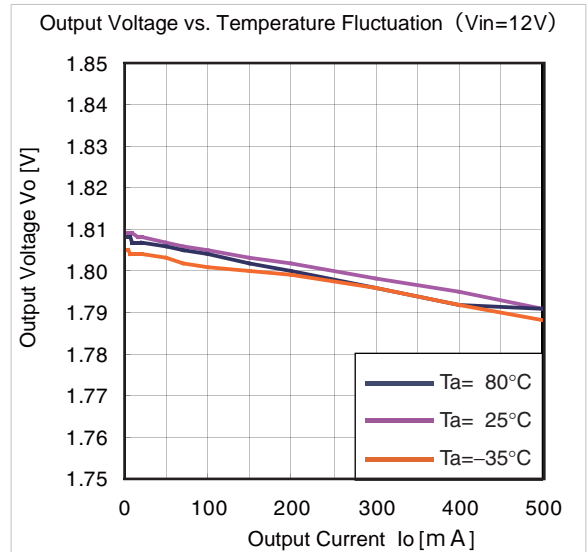
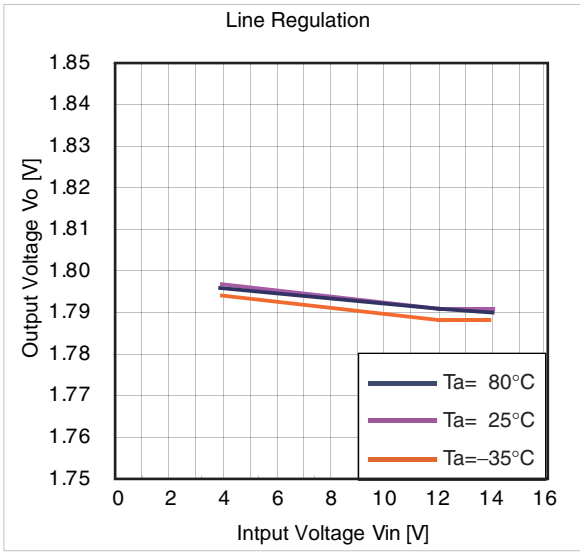

●BP5275-25

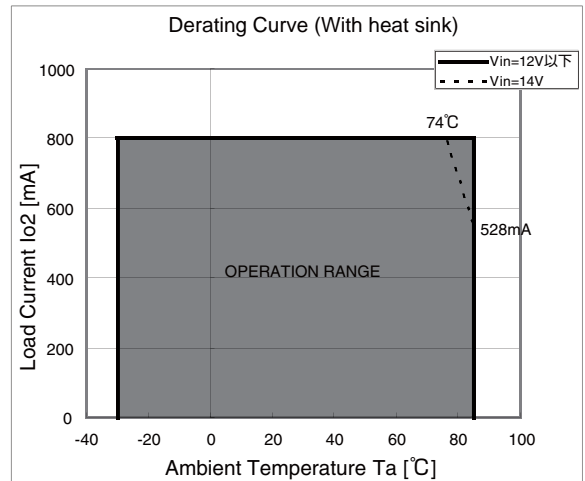
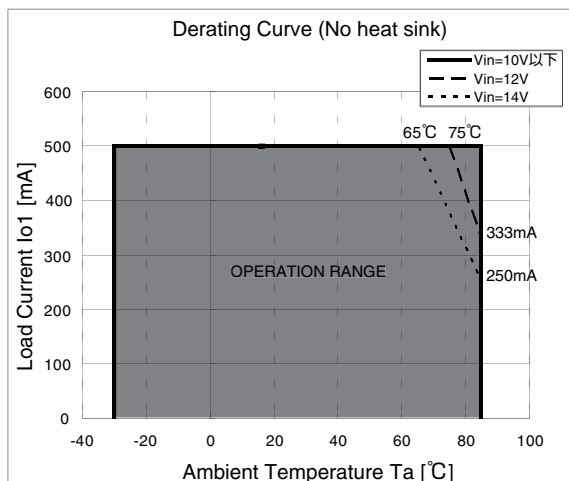
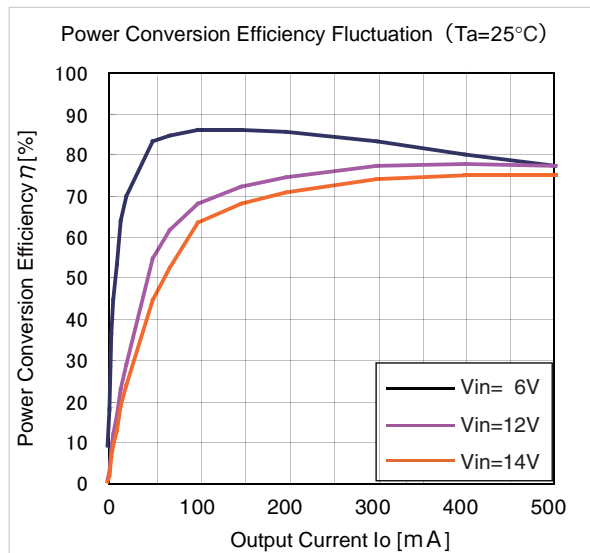
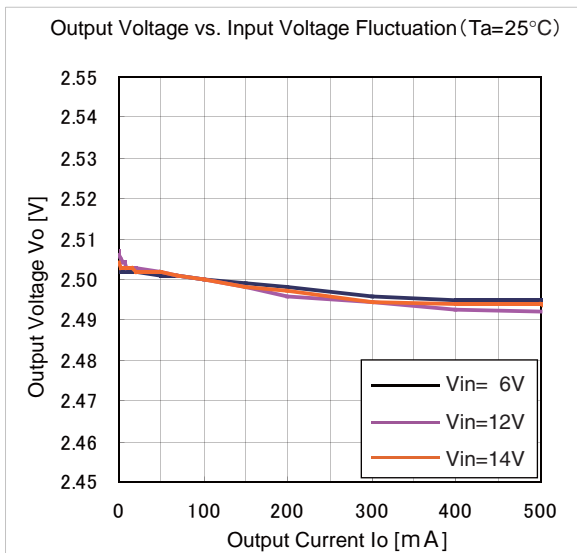
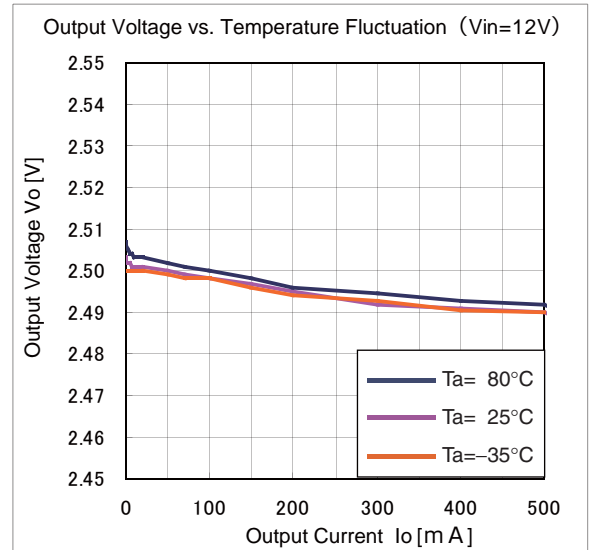
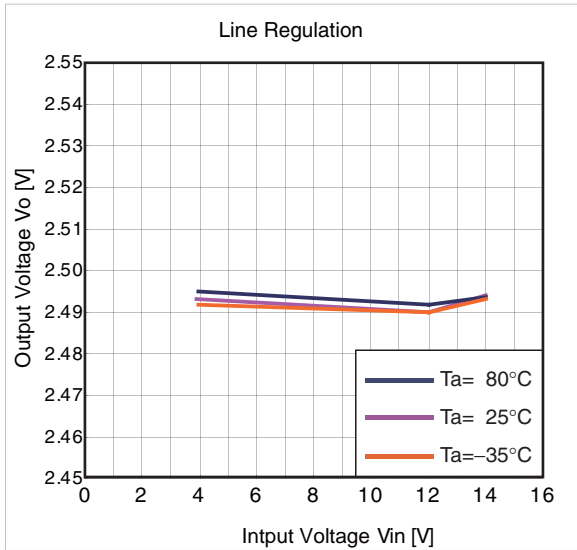

●BP5275-33

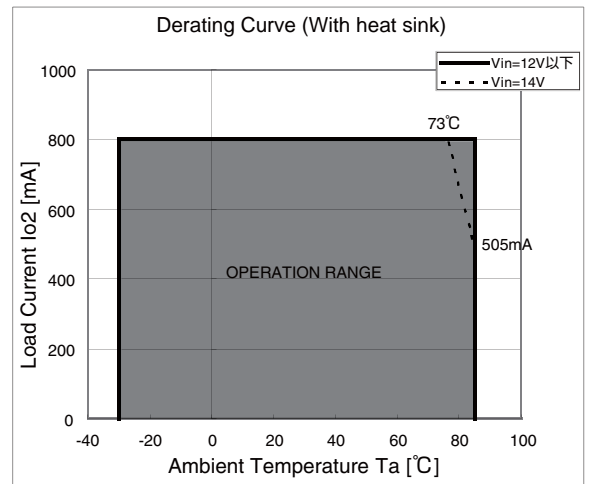
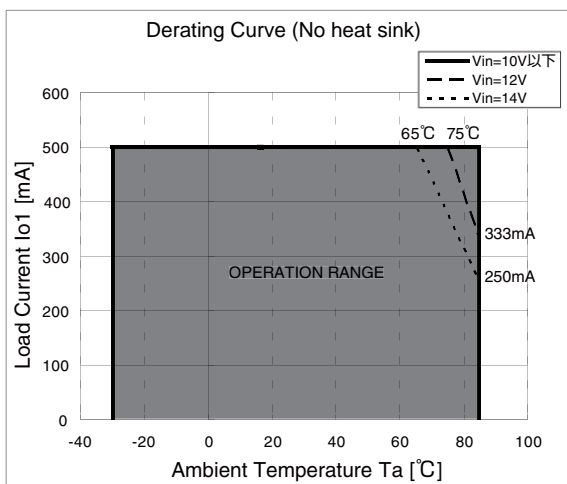
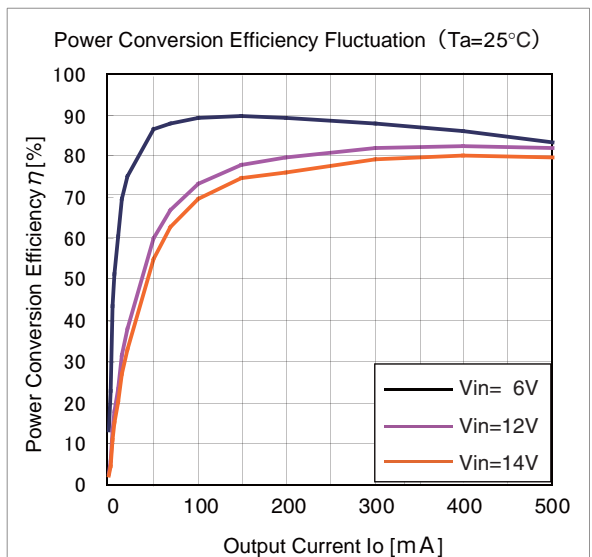
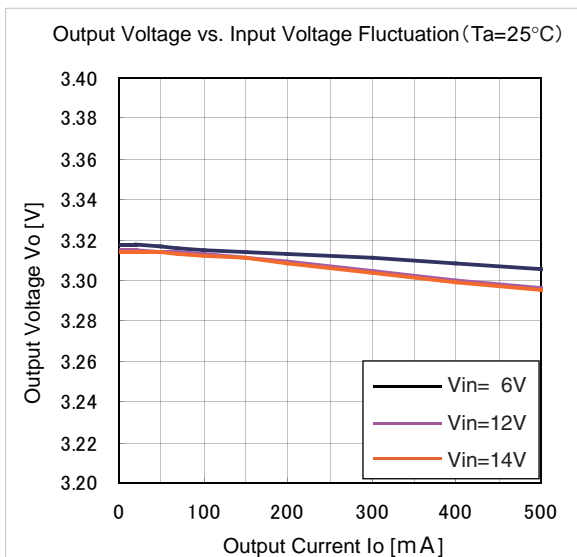
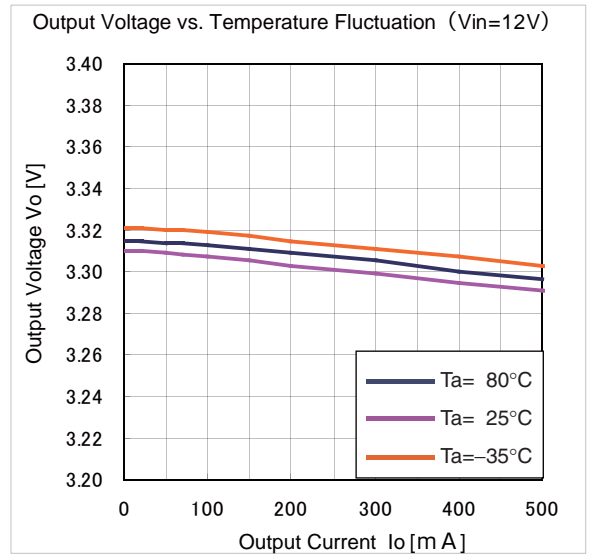
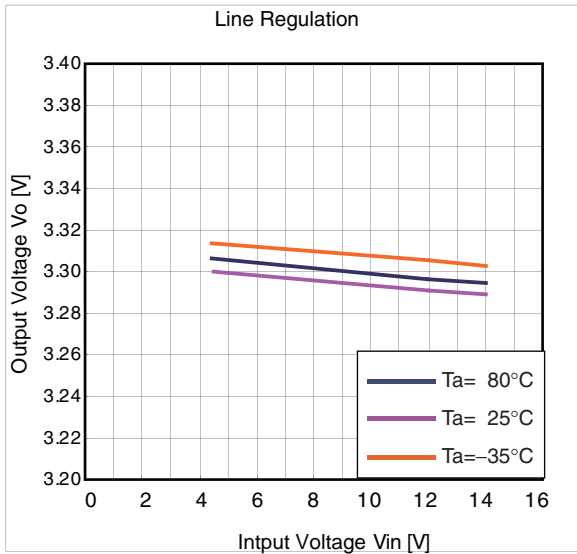

●BP5275-50

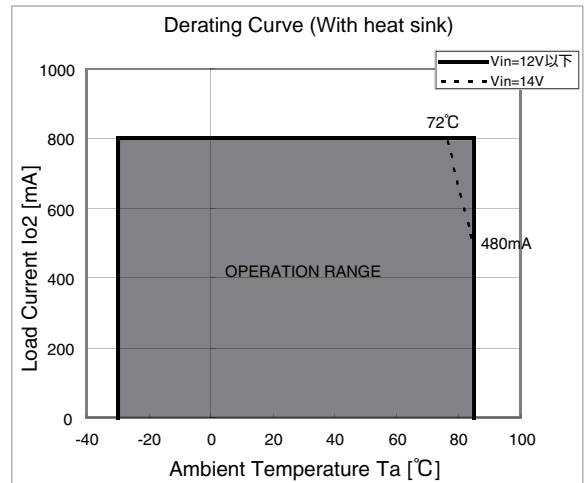
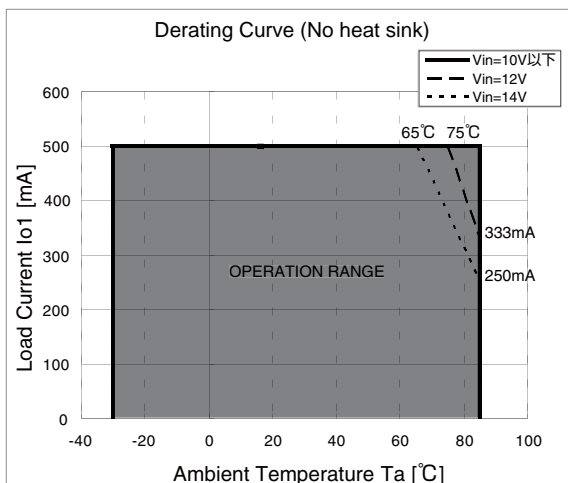
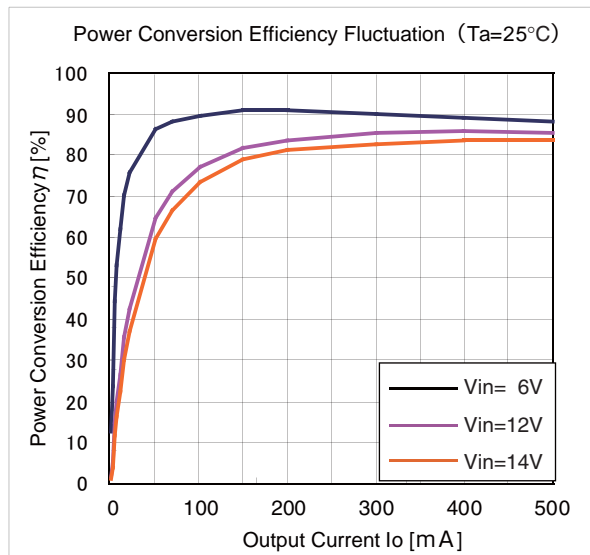
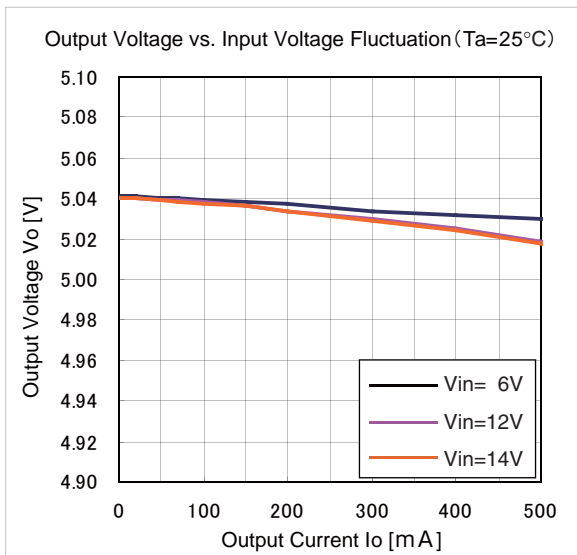
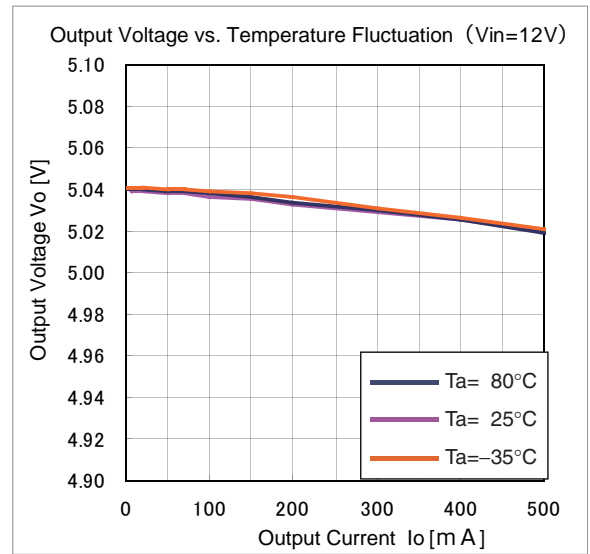
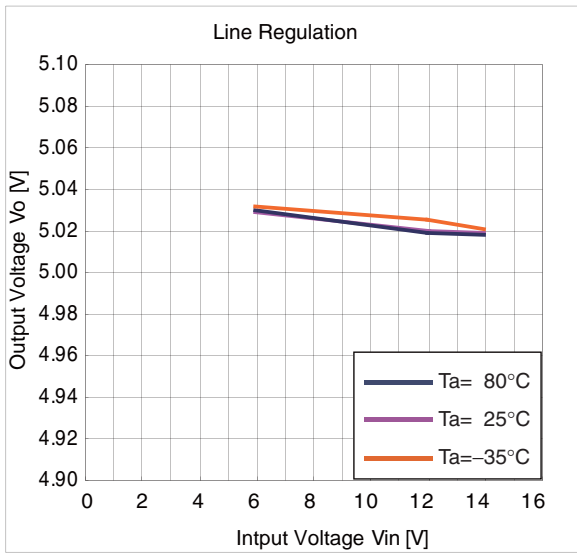

Power Module Usage Precautions

Safety Precautions

- 1) The products are designed and manufactured for use in ordinary electronic equipment (i.e. AV/OA/telecommunication/amusement equipment, home appliances). Please consult with the Company's (ROHM) sales staff if intended for use in devices requiring high reliability (e.g. medical/transport/aircraft/spacecraft equipment, nuclear power/fuel controllers, automotive/safety devices) and whose malfunction may result in injury or death. In this case, failsafe measures must be taken, including the following:
 - [a] Installation of protection circuits in order to improve system safety
 - [b] Incorporation of redundant circuits in the case of single-circuit failure
- 2) The products are designed for use under normal conditions. Application in special environments can cause a deterioration in product performance. Therefore, verification and confirmation of product performance, prior to use, is recommended. The following environments are considered to be 'special':
 - [a] Outdoors, exposed to direct sunlight or dust
 - [b] In contact with liquids, such as water, oils, chemicals, or organic solvents
 - [c] In areas where exposure to the sea air or corrosive gases (i.e. Cl₂, H₂S, NH₃, SO₂, NO₂) can occur
 - [d] In places where the products may be in contact with static electricity or electromagnetic waves
 - [e] In proximity to heat-producing items, plastic cords, or flammable materials
 - [f] In contact with sealing or coating products, such as resin
 - [g] In contact with unclean solder or exposed to water or water-soluble cleaning agents used after soldering
 - [h] In areas where dew condensation occurs
- 3) The products are not designed to be radiation resistant
- 4) The Company is not responsible for any problems resulting from use of the products under conditions not recommended herein.
- 5) The Company should be notified of any product safety issues. Moreover, product safety issues should be periodically monitored by the customer.

Application Notes

- 1) A sufficient margin must be allowed if changes are made to the peripheral circuit due to variations in the inherent tolerances of the external components as well as transient and static characteristics. In addition, please be aware that the Company has not conducted investigations on whether or not particular changes in the example application circuits would result in patent infringement.
- 2) The application examples, their constants, and other types of information contained herein are applicable only when the products are used in accordance with standard methods. Therefore, if mass production is intended, sufficient consideration to external conditions must be made.

Notes Regarding Industrial Property

- 1) The specifications included herein contain information related to the Company's industrial property. Their use other than pertaining to the relevant products is forbidden. Duplication and/or disclosure to a third party without express written permission is strictly prohibited.
- 2) Product information and data, including application examples, contained in the specifications are for reference purposes only; the Company does not guarantee the industrial/intellectual property rights or any other rights of a third party. Accordingly, the Company shall not bear responsibility for:
 - [a] Infringement of the intellectual property rights of a third party
 - [b] Problems arising from the use of the products listed herein
- 3) The Company prohibits the purchaser from exercising or using the intellectual/industrial property rights or any rights belonging to or are controlled by the Company, other than the right to use, sell, or dispose of the products.

Notes

No copying or reproduction of this document, in part or in whole, is permitted without the consent of ROHM Co.,Ltd.

The content specified herein is subject to change for improvement without notice.

The content specified herein is for the purpose of introducing ROHM's products (hereinafter "Products"). If you wish to use any such Product, please be sure to refer to the specifications, which can be obtained from ROHM upon request.

Examples of application circuits, circuit constants and any other information contained herein illustrate the standard usage and operations of the Products. The peripheral conditions must be taken into account when designing circuits for mass production.

Great care was taken in ensuring the accuracy of the information specified in this document. However, should you incur any damage arising from any inaccuracy or misprint of such information, ROHM shall bear no responsibility for such damage.

The technical information specified herein is intended only to show the typical functions of and examples of application circuits for the Products. ROHM does not grant you, explicitly or implicitly, any license to use or exercise intellectual property or other rights held by ROHM and other parties. ROHM shall bear no responsibility whatsoever for any dispute arising from the use of such technical information.

The Products specified in this document are intended to be used with general-use electronic equipment or devices (such as audio visual equipment, office-automation equipment, communication devices, electronic appliances and amusement devices).

The Products specified in this document are not designed to be radiation tolerant.

While ROHM always makes efforts to enhance the quality and reliability of its Products, a Product may fail or malfunction for a variety of reasons.

Please be sure to implement in your equipment using the Products safety measures to guard against the possibility of physical injury, fire or any other damage caused in the event of the failure of any Product, such as derating, redundancy, fire control and fail-safe designs. ROHM shall bear no responsibility whatsoever for your use of any Product outside of the prescribed scope or not in accordance with the instruction manual.

The Products are not designed or manufactured to be used with any equipment, device or system which requires an extremely high level of reliability the failure or malfunction of which may result in a direct threat to human life or create a risk of human injury (such as a medical instrument, transportation equipment, aerospace machinery, nuclear-reactor controller, fuel-controller or other safety device). ROHM shall bear no responsibility in any way for use of any of the Products for the above special purposes. If a Product is intended to be used for any such special purpose, please contact a ROHM sales representative before purchasing.

If you intend to export or ship overseas any Product or technology specified herein that may be controlled under the Foreign Exchange and the Foreign Trade Law, you will be required to obtain a license or permit under the Law.



Thank you for your accessing to ROHM product informations.
More detail product informations and catalogs are available, please contact us.

ROHM Customer Support System

<http://www.rohm.com/contact/>